



**TOYOTA**

ALWAYS A  
**BETTER WAY**

# Land Cruiser

## Mirror cover

Installation Instructions

Model year: 2009/08, 2013/08

Vehicle code: \*\*J15\*\*-G\*\*\*\*W

Part number: 08409-60820

Manual reference number: AIM 001 788-1

# Revision record

Rev. No.	Date	Page	Picture	Update	New	Deleted steps
1	19/07/2013	1		Model year		
		5	Check Sheet		x	

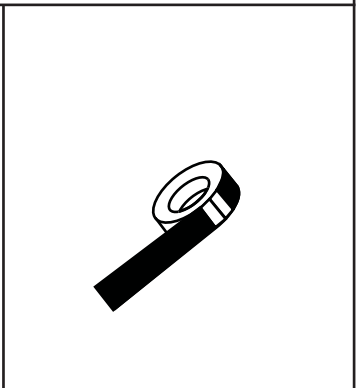
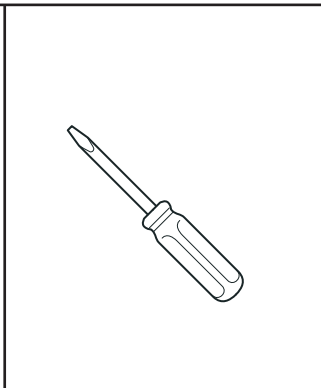
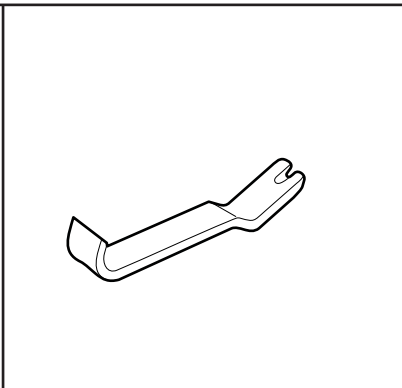
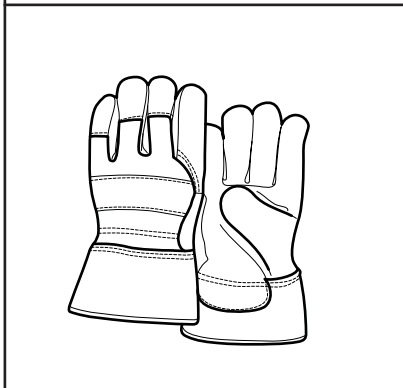
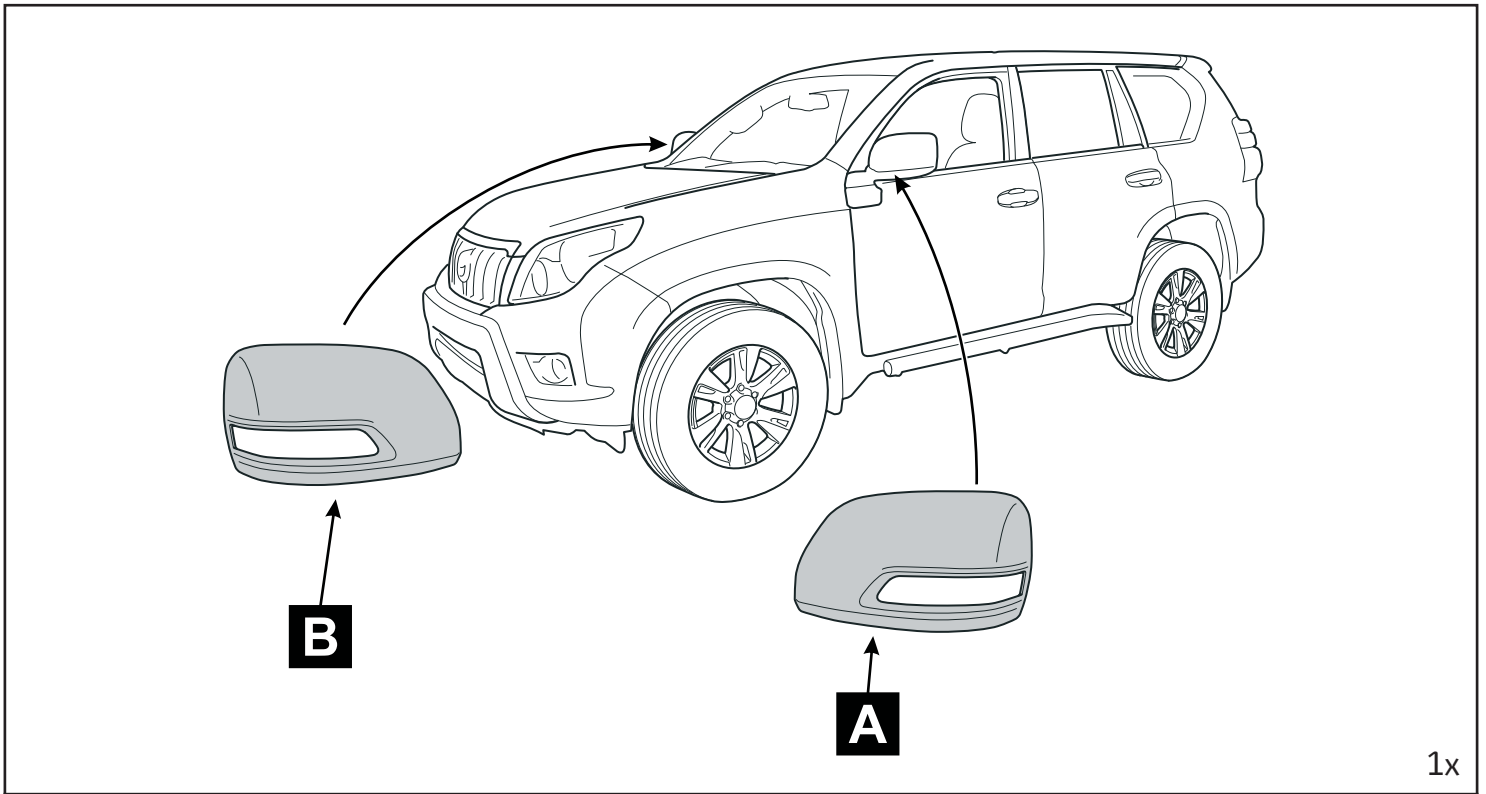

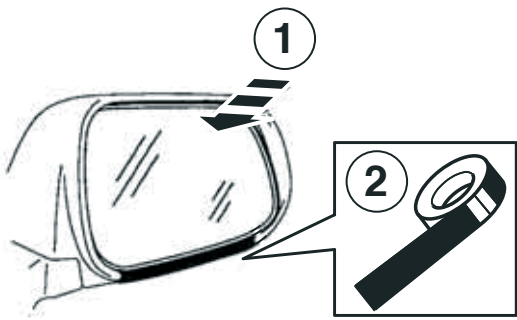

1

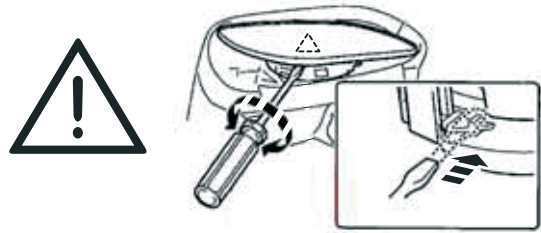

2

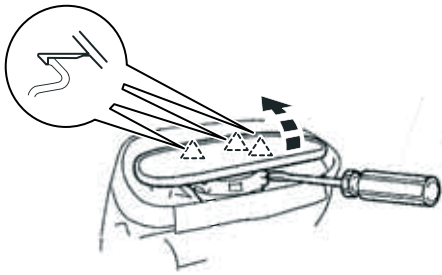

3

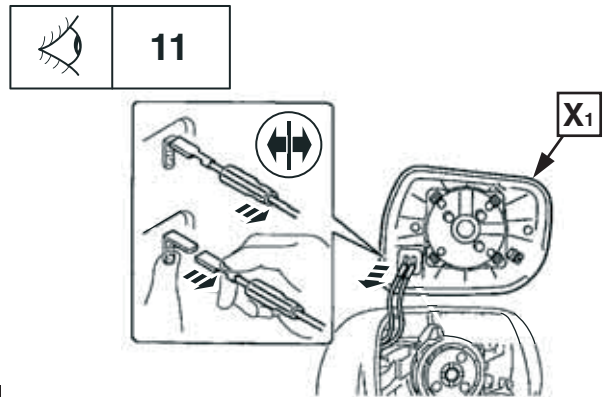

4

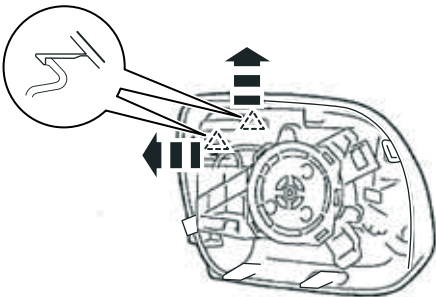

5

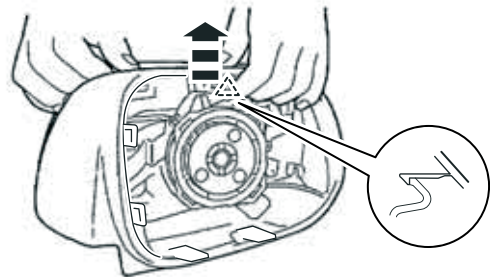

6

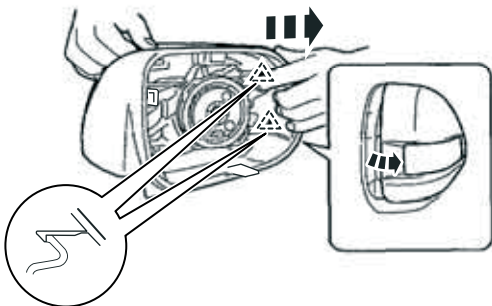

7

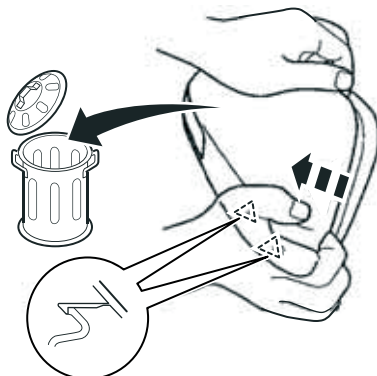

8

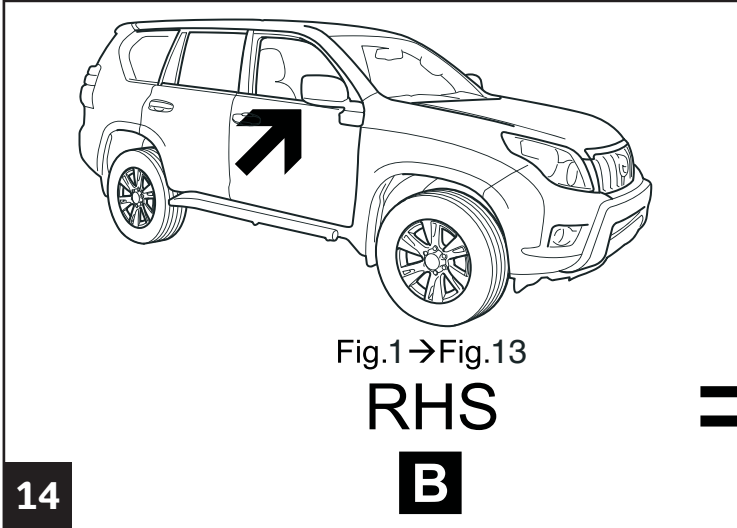
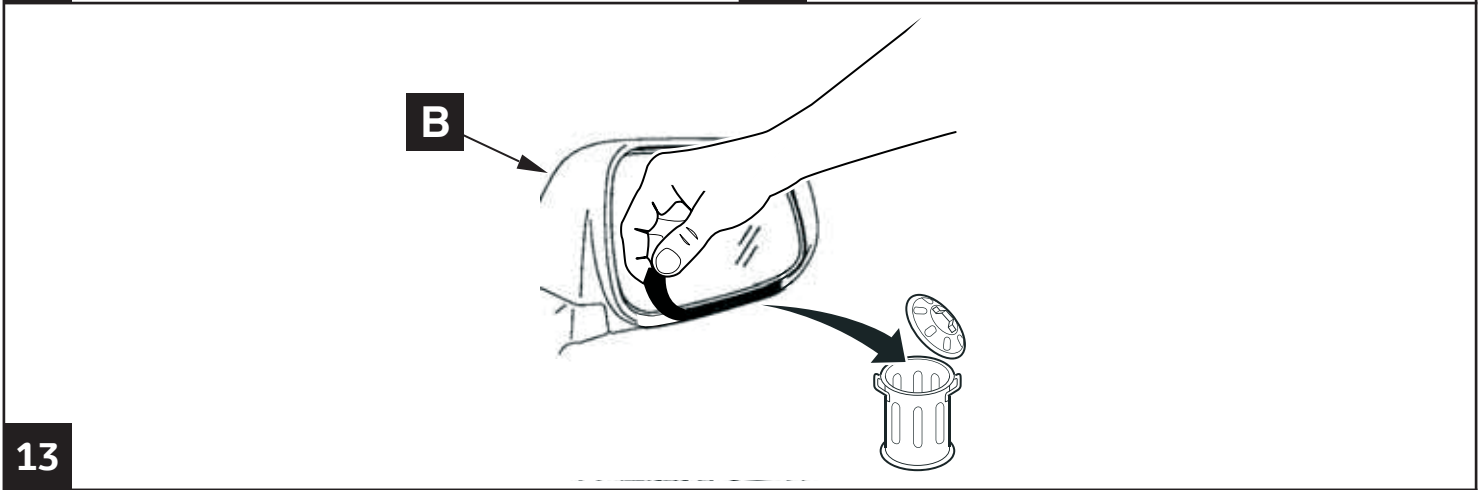
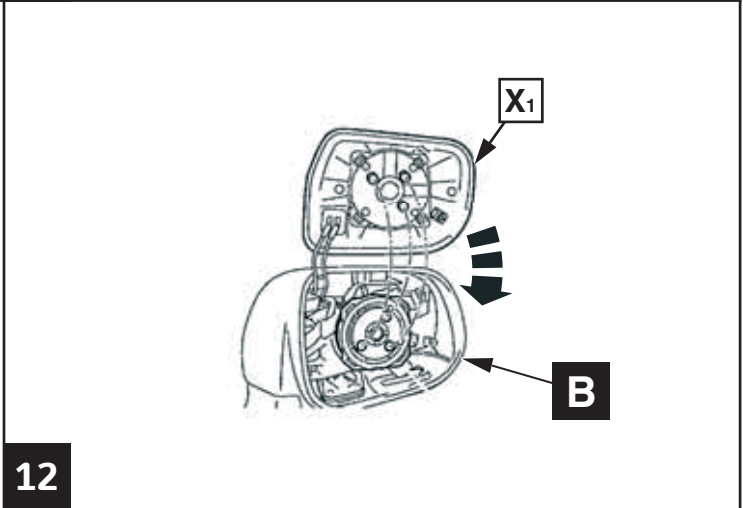
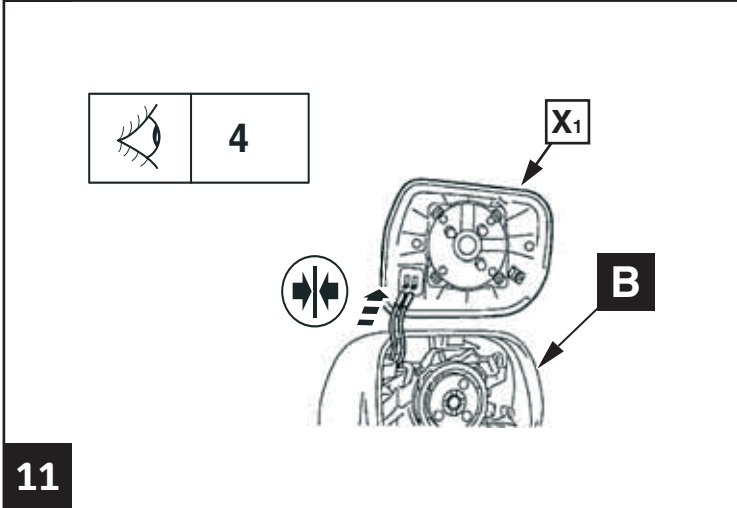
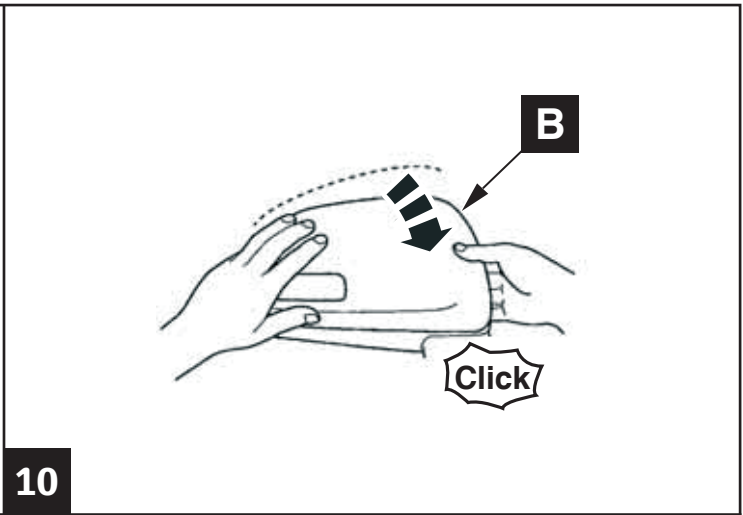
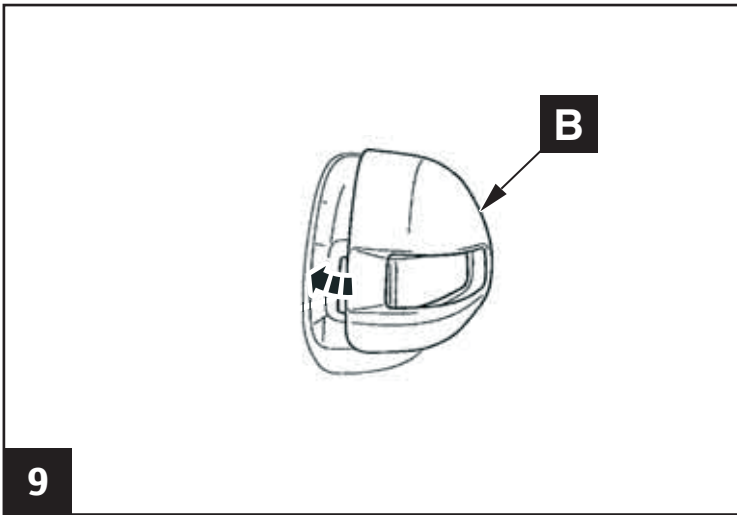

Fig.1→Fig.13

**RHS**

**B**

**=**

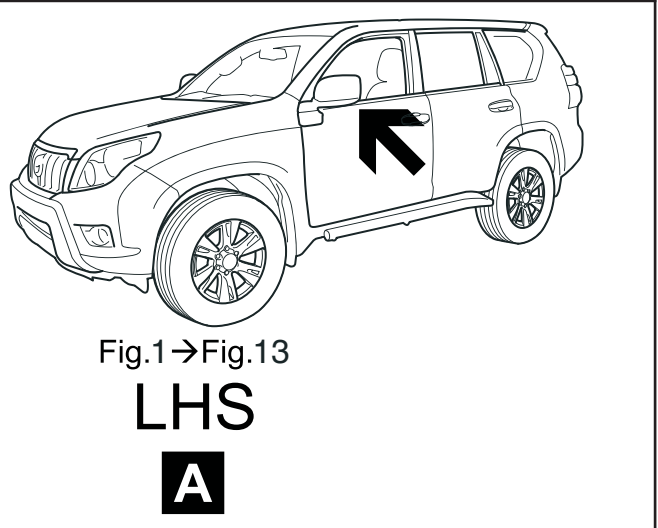

Fig.1→Fig.13

**LHS**

**A**

# CHECK SHEET



**TOYOTA**

**Model / Year**      **Land Cruiser**      **Mirror cover**  
 2009/08, 2013/08

□ □ □ □ □ □ □ □ □ □ □ □ □ □ □ □ □ □

ALWAYS A  
 BETTER WAY

**P/N = OK**

□

**+2°C**      **+2°C**

□      □

**LIR**      **LIR**

□      □

**= OK**

□

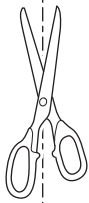

**Installation Date:**  
 . . / . . / . . . .

**Technician Name & Signature:**

**Stamp:**